

H&S

M6 & M9 MERGERS

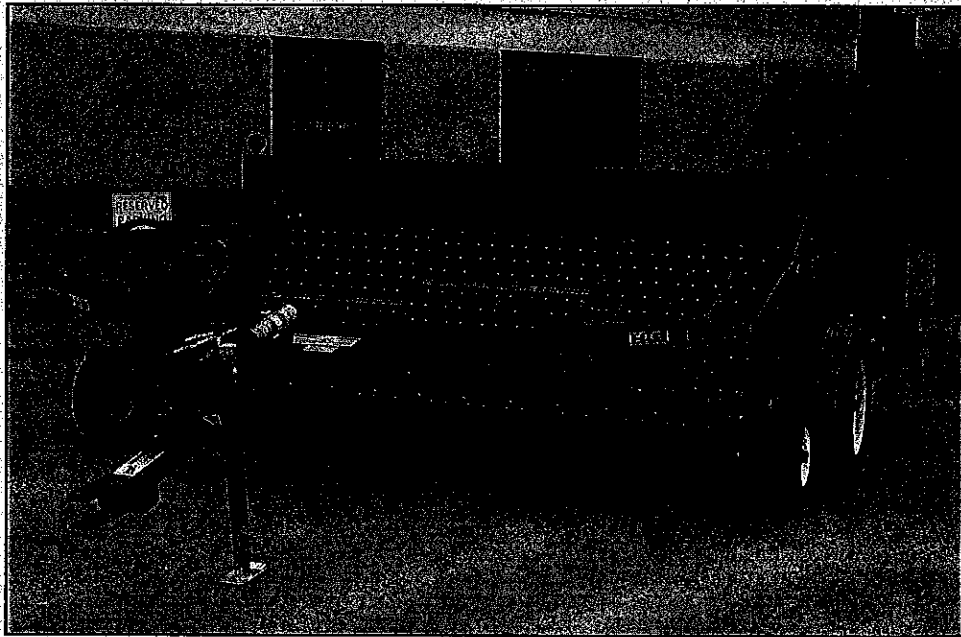

WARNING

READ AND UNDERSTAND THIS MANUAL
BEFORE OPERATING THIS EQUIPMENT.

UNSAFE OPERATION OR MAINTENANCE OF THIS EQUIPMENT CAN RESULT IN SERIOUS
INJURY OR DEATH.

PARTS & OPERATOR'S INSTRUCTIONS

2-24-2006

Manufactured By

H&S MANUFACTURING CO., INC.

P.O. BOX 768 • (715) 387-3414 FAX (715) 384-5463

MARSHFIELD, WISCONSIN 54449

H&S

M6 & M9 MERGERS

CONTENTS

Warranty & Warranty Registration Card	1-2
Dealer Pre-Delivery & Delivery Checklist	3
Be Alert Symbol	5
Explanation of Safety Signs	6
Danger - Warning Decals	7
Warning - Owner Must Read and Understand	8
Operation	9
Transport Lock	10
Adjustments	11-12
Hydraulics	13
Lubrication Guide	14-15
Options	16
Ordering Parts - About Improvements	17
Decal Location & Identification	18-19
Figure 1 - M6' & M9' Merger Main Frame / Pole	20-21
Figure 2 - M6' & M9' Merger Pick-Up Head	22-23
Figure 3 - M6' & M9' Merger Hydraulics	24-25
Figure 4 - M6' & M9' Merger Electrical Wiring / Lights	26
Figure 5 - M6' & M9' Merger Optional Windrow Inverter	27
Figure 6 - M6' & M9' Merger Optional Accelerator	28-29
Figure 7 - M6' & M9' Merger Hydraulic Cylinder 8"	30
Figure 8 - M6' & M9' Merger 2' Extention	31
Service Notes	32
SPECIFICATIONS	INSIDE BACK COVER

WARRANTY

Mr. Owner: Before Operating—Read and Understand Operating and Safety Instructions

H&S Manufacturing Co., Inc. truly believes you have made a wise choice and a sound and lasting investment. Many years of development have made available these quality machines to assure you the performance and reliability you need. **We ask you to read the following agreement and warranty as this unit is subject to this warranty and agreement and no other.**

H&S MANUFACTURING CO., INC. WARRANTY

H&S Manufacturing Co., Inc. ("H&S") warrants this product to be free from defect in material and workmanship. Except as noted below, this warranty term is twelve (12) months from the date of delivery of the product to the original purchaser by an authorized H&S dealer. Under this warranty, H&S will repair or replace, at its option, any covered part which is found to be defective in material or workmanship during the applicable warranty term. In no case will the covered repair cost of a part or parts exceed the replacement cost of that part. Warranty service must be performed by H&S or a dealer authorized by H&S to sell and/or service the product involved, which will use only new or remanufactured parts or components furnished by H&S. This warranty includes approved parts and labor to fix the product but does not include, and the purchaser is responsible for, any service call and/or transportation of the product to and from the dealer's place of business, for any premium charged for overtime labor requested by the purchaser, and for any service work not directly related to any defect covered under this warranty. This warranty includes only those components of the product manufactured by H&S. Warranty for any component not manufactured by H&S including, but not limited to, engines, batteries, tires, rims, hydraulic motors, pumps, etc., are covered by the warranty, if any, provided separately by their respective manufacturers.

This warranty in all its parts, is extended solely to the original purchaser of the product, is terminated upon any subsequent transfer or sale from or by the original purchaser and extends no third party benefits or rights whatsoever.

The warranty term for any product used in any commercial, custom for hire or rental application, is limited to six (6) months from the date of delivery of the product to the original purchaser by an authorized H&S dealer.

Polybonded (polyethylene and plywood) panels utilized in H&S Manure Spreaders are warranted, to the original purchaser, to not wear through and the polyethylene overlay to not tear free of the plywood for the functional life to the spreader. This specific warranty on polybonded panels includes only replacement of any defective panel part without any allowance for labor beyond the terms of the general warranty (12 or 6 months), and is further limited to manure spreaders used to spread normal agricultural manure.

This warranty does not include: (1) Any product that has been altered or modified in ways not approved by H&S; (2) Depreciation or damage caused by normal wear, misuse, improper or insufficient maintenance, improper operation, accident or failure to follow the product Operator Manual recommendations and product decal recommendations; (3) Normal maintenance parts and service; (4) Repairs made with parts other than those available from H&S or performed by anyone other than H&S or a dealer authorized by H&S to sell and/or service the product involved.

To secure warranty service the purchaser must report the product defect to a dealer authorized by H&S to sell and/or service the product involved within the applicable warranty term together with evidence of the warranty start date and make the product available to that dealer within a reasonable period of time.

THERE ARE NO WARRANTIES WHICH EXTEND BEYOND THE DESCRIPTION ON THE FACE OF THIS WARRANTY. H&S and the companies affiliated with it makes no warranties, representations, or promises, express or implied, as to the quality or performance or freedom from defect of its products other than those set forth above and **NO IMPLIED WARRANTY OF MERCHANTABILITY, FITNESS OR FITNESS FOR A PARTICULAR PURPOSE IS MADE. IN NO EVENT WILL THE DEALER, H&S OR ANY COMPANY AFFILIATED WITH H&S BE LIABLE FOR INCIDENTAL OR CONSEQUENTIAL DAMAGES.** The **ONLY REMEDY** the purchaser has in connection with the breach of performance of any warranty on H&S products are those set forth above.

The selling dealer has no authority to make any representation or promise on behalf of H&S, or to modify the terms or limitations of this warranty in any way.

2/16/2004

WARRANTY REGISTRATION

Date of Purchase _____

Purchaser _____ Address _____

City _____ State _____ Zip _____

Product _____ Model # _____ Serial # _____

Dealer _____ Address _____

City _____ State _____ Zip _____

Signature of original buyer

**FILL OUT AND MAIL
IMMEDIATELY TO MAKE
WARRANTY EFFECTIVE**



IMPORTANT!

Tear on dotted line, provide the information requested on the card. The H&S Warranty is valid **“only”** after this card is received and recorded at H&S Mfg. Co. Mail at once. No postage is required in the U.S.A.

This Is Your Warranty Card
Please Fill Out
And Mail Immediately



NO POSTAGE
NECESSARY
IF MAILED
IN THE
UNITED STATES

BUSINESS REPLY MAIL

FIRST CLASS MAIL Permit No. 195 Marshfield, WI 54449

POSTAGE WILL BE PAID BY ADDRESSEE

H&S Manufacturing Co., Inc.

PO Box 768
Marshfield WI 54449-9963



AFTER COMPLETION, DEALER SHOULD REMOVE AND RETAIN FOR RECORDS

**H&S
DEALER PRE-DELIVERY CHECK LIST**

After the Mini Merger has been completely set-up, check to be certain it is in correct operating order before delivering to the customer. The following is a list of points to inspect. Check off each item as you have made the proper adjustments and found the item operating satisfactorily.

- All shields and guards are in place and fastened.
- All grease fittings have been lubricated - See lubrication guide in this manual.
- All mechanisms are operating trouble free.
- Belts are properly adjusted.
- All bolts and fasteners are tight.
- All decals are in place and legible.
- Lights and wiring functioning properly.

_____	_____
(Dealer's Name)	Model Number
_____	_____
	Serial Number
_____	_____
(Signature of Pre-Delivery Inspector)	(Inspection Date)

DEALER DELIVERY CHECK LIST

This check list that follows is an important reminder of valuable information that should be passed on to the customer at the time this Mini Merger is delivered.

Check off each item as you explain it to the customer.

This pre-delivery check list, when properly filled out and signed assures the customer that the pre-delivery service was satisfactorily performed.

- Explain to the customer that the pre-delivery inspection was made.
- Explain to the customer all the safety precautions they must exercise when operating this unit.
- Explain to customer that regular lubrication is required for proper operation and long life of machine. Show customer the lubrication section of Owner's Manual.
- Give the customer Owner's Manual and make sure he reads and understands all operating and service instructions.
- Record Serial Number on Page 17 of this Manual.
- Have customer sign a completed "Warranty Registration," and mail it promptly.

Date Delivered _____ Dealer's Name _____

By _____

Signature of Original Buyer

Note: Warranty is not valid until warranty card is completed and returned to H&S Mfg. Co., Inc.

(Remove Dealers File Copy At Perforation)





**BE
ALERT!** **YOUR SAFETY
IS INVOLVED.**

THIS SYMBOL IS USED THROUGHOUT THIS BOOK WHENEVER YOUR PERSONAL SAFETY IS INVOLVED. TAKE TIME TO BE CAREFUL. REMEMBER: THE CAREFUL OPERATOR IS THE BEST OPERATOR. MOST ACCIDENTS ARE CAUSED BY HUMAN ERROR. CERTAIN PRECAUTIONS MUST BE OBSERVED TO PREVENT THE POSSIBILITY OF INJURY OR DAMAGE.

TRACTORS

This operator's manual uses the term "Tractor" when identifying the power source.

H&S MANUFACTURING CO. INC.

RECOGNIZE SAFETY INFORMATION

This is the safety-alert symbol. When you see this symbol on your machine or in this manual, be alert to the potential for personal injury.

Follow recommended precautions and safe operating practices.



UNDERSTAND SIGNAL WORDS

A signal word—DANGER, WARNING, or CAUTION—is used with the safety-alert symbol. DANGER identifies the most serious hazards.

Safety signs with signal word DANGER or WARNING are typically near specific hazards.

General precautions are listed on CAUTION safety signs.



WARNING



CAUTION



FOLLOW SAFETY INSTRUCTIONS

Carefully read all safety messages in this manual, and all safety signs on your machine. Follow all recommended precautions and safe operating procedures.

Keep signs in good condition. Immediately replace any missing or damaged signs.

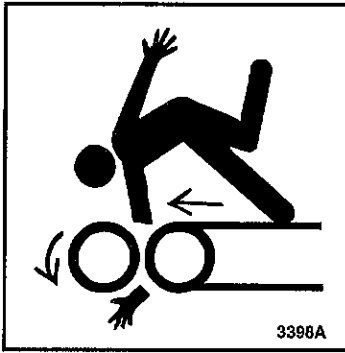

! DANGER

STAY CLEAR OF MOVING PARTS

FAILURE TO HEED THIS WARNING MAY RESULT IN PERSONAL INJURY OR DEATH

KEEP CLOTHING, YOURSELF AND OTHERS WELL CLEAR.

! DANGER

SHUT ENGINE COMPLETELY OFF BEFORE ADJUSTING OR SERVICING MACHINE.

MACHINE MAY START UNEXPECTEDLY

FAILURE TO HEED THIS WARNING MAY RESULT IN PERSONAL INJURY OR DEATH 3398C

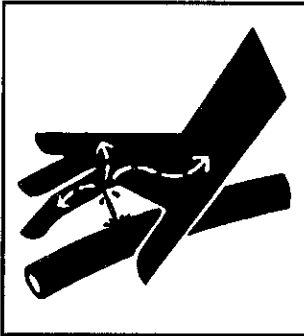

! WARNING

DO NOT GO NEAR LEAKS

- High pressure oil easily punctures skin causing serious injury, gangrene or death.
- If injured, seek emergency medical help. Immediate surgery is required to remove oil.
- Do not use finger or skin to check for leaks.
- Lower load or relieve hydraulic pressure before loosening fittings.

11599

! WARNING

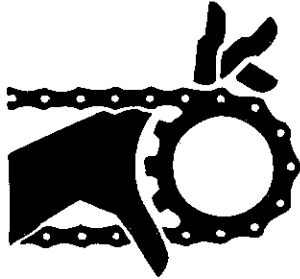

DO NOT REMOVE SHIELDS

MOVING PARTS INSIDE

1494K

! DANGER



STAY CLEAR OF MOVING PARTS

FAILURE TO HEED THIS WARNING MAY RESULT IN PERSONAL INJURY OR DEATH

KEEP CLOTHING, YOURSELF AND OTHERS WELL CLEAR.

73101

! WARNING

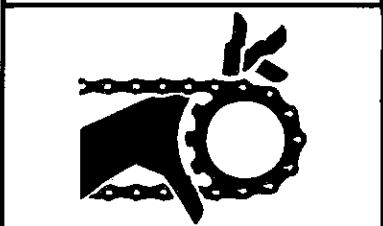

DO NOT OPERATE THIS EQUIPMENT IF THIS DECAL IS EXPOSED. REPLACE SAFETY SHIELDS. FAILURE TO HEED MAY RESULT IN SERIOUS INJURY OR DEATH.

3894

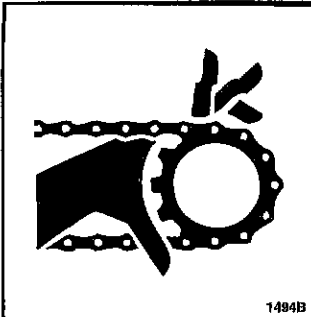

! WARNING

DO NOT REMOVE SHIELDS

MOVING PARTS INSIDE

! WARNING

HELP AVOID INJURY

- READ & UNDERSTAND THE OPERATORS MANUAL PROVIDED WITH THIS MACHINE. IF MISPLACED CALL H & S MANUFACTURING AT 715-387-3414 WITH MODEL AND SERIAL NUMBER.
- UNDERSTAND ALL SAFETY WARNINGS AND FUNCTION OF CONTROLS.
- KEEP SAFETY DEVICES IN PLACE AND WORKING.
- KEEP YOURSELF AND OTHERS WELL CLEAR OF MOVING PARTS.
- DISCONNECT ALL POWER BEFORE SERVICING OR CLEANING THIS MACHINE.
- DO NOT EXCEED 20 MPH

72203A

H&S 6' & 9' MERGER



WARNING

TO PREVENT SERIOUS INJURY OR DEATH

BEFORE YOU ATTEMPT TO OPERATE THIS EQUIPMENT, READ AND STUDY THE FOLLOWING INFORMATION. IN ADDITION, MAKE SURE THAT EVERY INDIVIDUAL WHO OPERATES OR WORKS WITH THIS EQUIPMENT, WHETHER FAMILY MEMBER OR EMPLOYEE, IS FAMILIAR WITH THESE SAFETY PRECAUTIONS.

KNOW HOW TO STOP MACHINE BEFORE STARTING IT.

If the machine becomes clogged, or when servicing disengage the tractor hydraulics. Stop the tractor engine and allow all mechanisms to stop before cleaning or working on the machine.

DO NOT attempt to perform maintenance or repair with tractor running or tractor hydraulics engaged.

DO NOT step up on machine at any time.

NEVER manually feed material into the pickup.

DO NOT allow minors to operate or be near the machine.

DO NOT ALLOW PERSONNEL OTHER THAN THE QUALIFIED OPERATOR NEAR THE MACHINE.

STAY CLEAR of machine when raising or lowering pickup.

Keep hands, feet, and clothing away from pickup and conveyor belts **WHEN THEY ARE IN MOTION.**

Loose or floppy clothing should not be worn by the operator.

Be sure the machine is clear of people, tools, and other objects before engaging tractor hydraulics.

NEVER start Mini Merger until all guards and safety shields are secured in place.

STAY CLEAR of hydraulic lines. They may be under extreme pressure or heat.

H&S Mfg. Co. always takes the operator and his safety into consideration and guards exposed moving parts for his protection. However, some areas cannot be guarded or shielded in order to assure proper operation. In addition, the operators manual and decals on the machine itself warn you of further danger and should be read and observed closely.

Study The Above Safety Rules

ATTENTION - BE ALERT - YOUR SAFETY IS INVOLVED

OPERATION

1. Check entire unit carefully before first operation. Tighten bolts and set screws that might have come loose in handling. Lubricate as explained in the lubrication guide.
2. Adjust tractor drawbar to allow for maximum clearance between drawbar and ground. Attach merger to tractor with a hitch pin that has a safety locking device.
3. Remove weight from lift jack and move jack to storage position.
4. Connect hydraulic hoses. (See Page 13)
5. Check tires and inflate to recommended pressure.
6. Run pickup and conveyor for several minutes to ensure proper assembly and lubrication. Successful operation will be achieved by periodic adjustments and experience of the operator. Make sure to read and understand all adjustments.

	<p>⚠ WARNING</p> <p>DO NOT GO NEAR LEAKS</p> <ul style="list-style-type: none">• High pressure oil easily punctures skin causing serious injury, gangrene or death.• If injured, seek emergency medical help. Immediate surgery is required to remove oil.• Do not use finger or skin to check for leaks.• Lower load or relieve hydraulic pressure before loosening fittings.
---	---

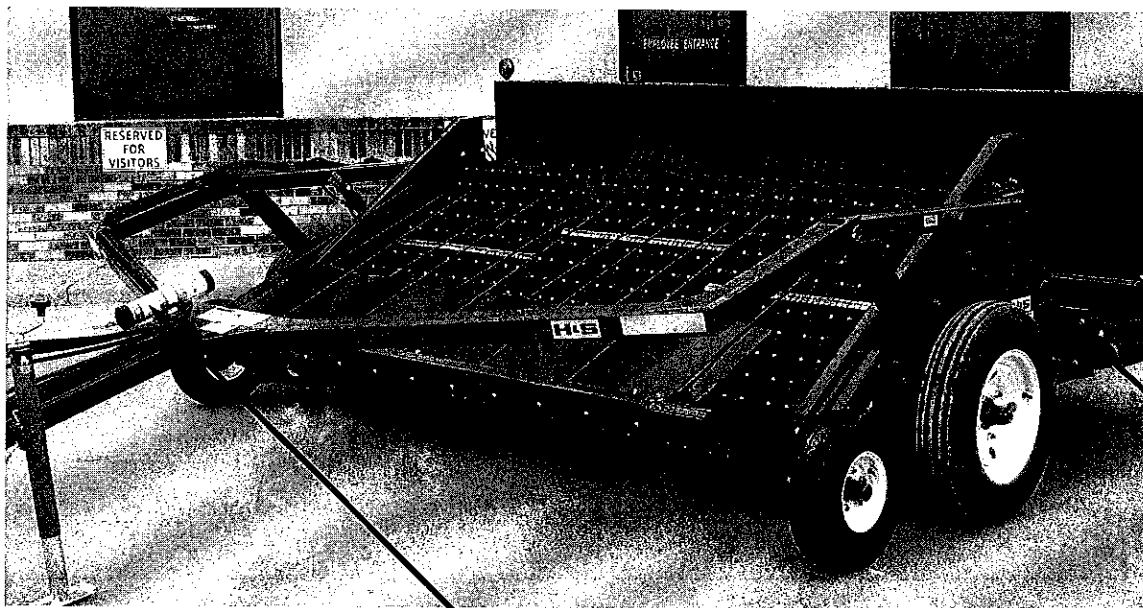

Operator Manual
Storage

Jack Storage

TRANSPORT LOCK

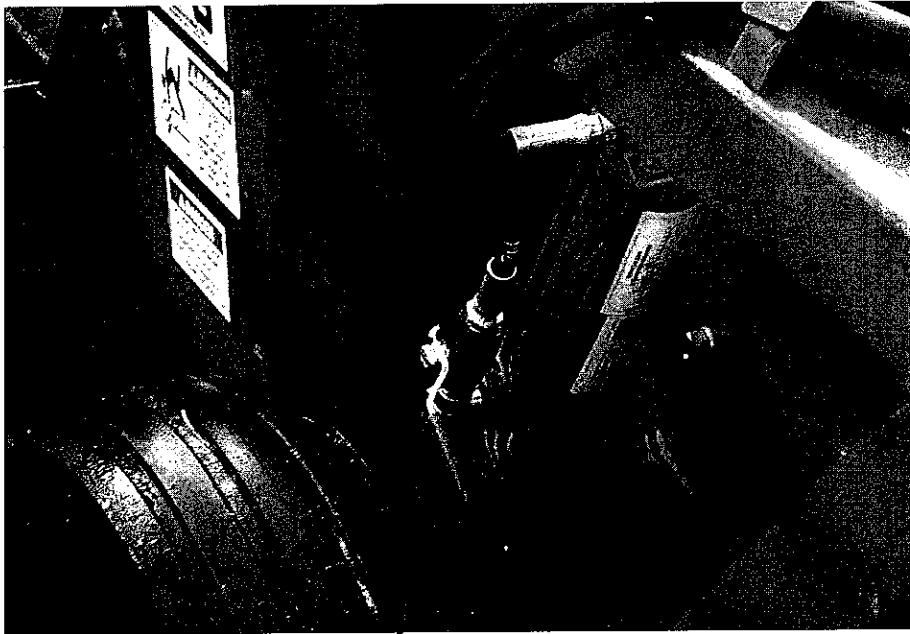

Transport Position

Located on the right side of the pick-up on the lift cylinder is the manual valve which locks the pick-up into transport position. Shown below is the valve in the locked and unlocked positions.

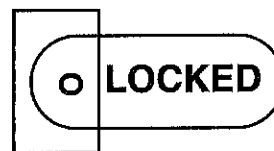

ADJUSTMENTS

TAIL WHEEL

The tail wheel is located at the right rear of the merger. Located on the tail wheel pivot spindle is an adjustable brake assembly. Adjust brake by tightening bolt (A). The brake should have enough tension to prevent zig-zag motion, but still allow the wheel to pivot when making corners. Improper adjustment will cause severe tire wear and damage to Merger.

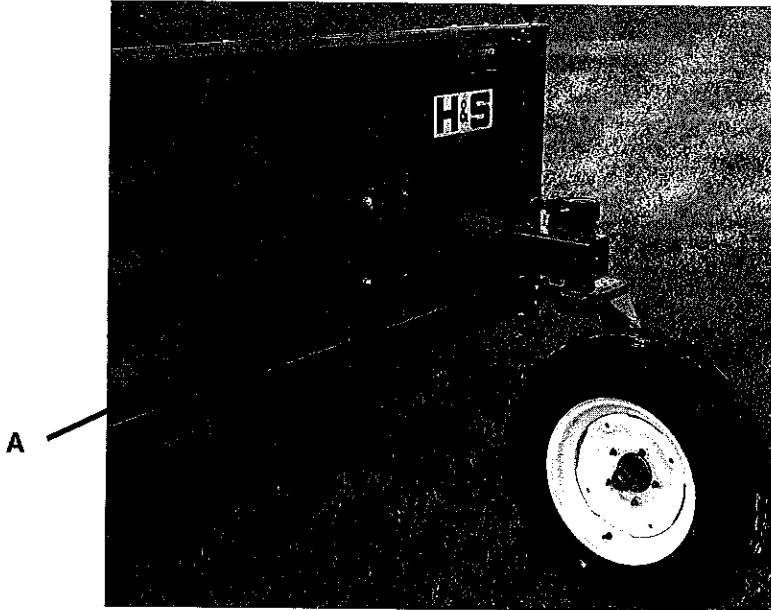

PICKUP ADJUSTMENTS

1. Pickup belts are adjusted by adjusting the take up bolt (B) located on both ends of the pickup bottom roller. The bearing bracket bolts (C) must be loosened before adjustment, and tightened after the desired belt tension is attained. Proper belt tension will be achieved when 1.5" of slack can be pulled in the center of the belts with minimal resistance. **DO NOT tighten pickup belts excessively.** Over-tightening may cause damage to belts or rollers. Loose belts will cause unnecessary tooth wear and breakage.

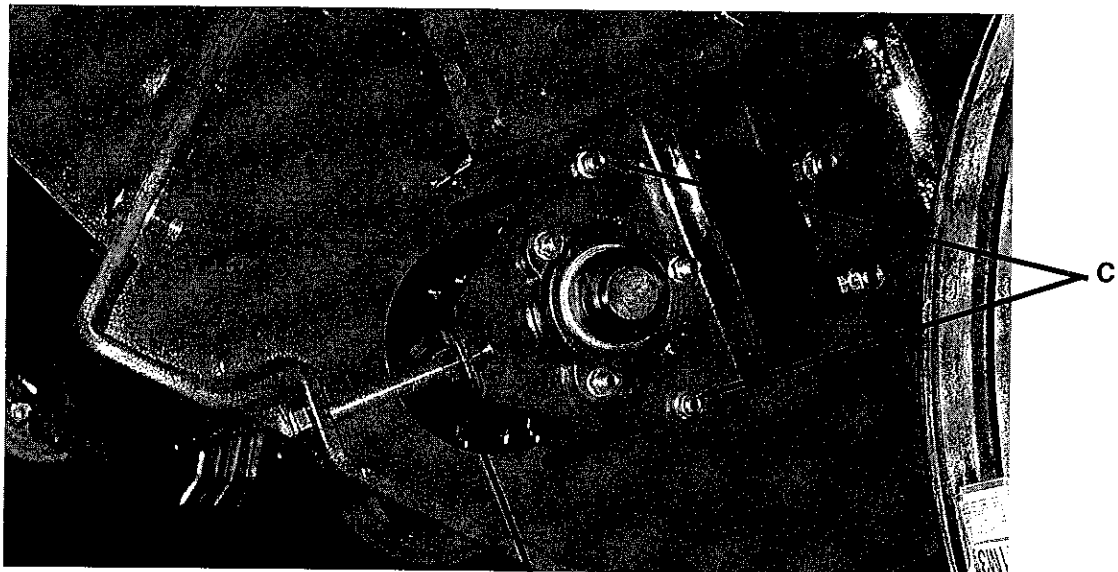

B

(Behind Gauge Wheel)

ADJUSTMENTS *(Continued)*

PICKUP HEAD

The pickup head should be adjusted according to the height of the stubble. Pickup height is adjusted by adjusting the gauge wheels located at both sides of the pickup head. Remove adjustment pin (A) and place in the desired hole position above the gauge wheel arm. Lower head and check for proper adjustment. Repeat process if necessary. Teeth should never be closer than 3/4" from the ground. When proper adjustment is obtained, remove pin (B) and place in hole as close as possible below gauge wheel arm to support gauge wheel when raising head. Excessive tooth wear and breakage will occur if teeth are touching the ground. Adjust both sides equally.

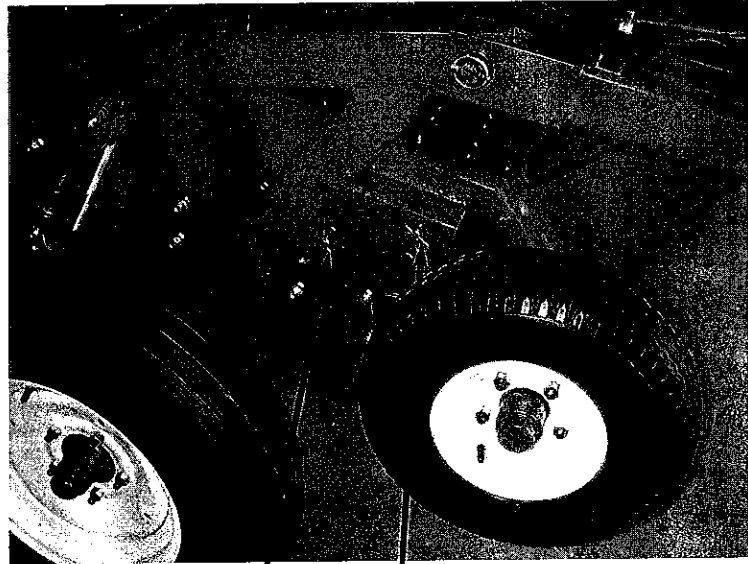

B

A

CONVEYOR ADJUSTMENTS

The cross conveyor belt tension can be adjusted by adjusting the nut against the spring on the take up bolts (C) located on left end of cross conveyor. Correct tension is achieved when springs (D) are compressed to 1.5".

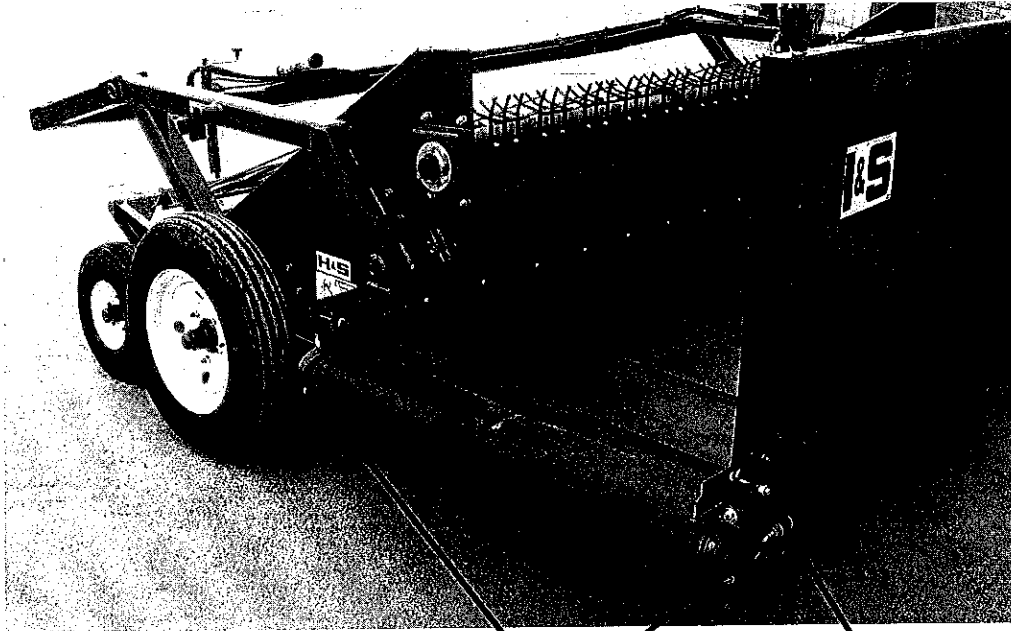

C

D

HYDRAULICS

There are four hydraulic hoses from the merger to the tractor. The two smaller, (3/8" diameter) hoses provide oil to the pickup lift cylinder (A).

The two larger (1/2" diameter) hoses provide oil to the hydraulic motors (B) running pickup belt and cross conveyor belt. Controlling speed of belts is done by adjusting oil flow at the tractor remote (if possible) or by adjusting the tractor throttle. Coordinate speed of belts with ground speed of tractor. To reverse direction of cross conveyor change hydraulic quick couplers at the cross conveyor drive motor (C). A flow of 16 GPM and pressure of 2,000 PSI is recommended to operate the merger efficiently.

	⚠ WARNING
	DO NOT GO NEAR LEAKS <ul style="list-style-type: none">• High pressure oil easily punctures skin causing serious injury, gangrene or death.• If injured, seek emergency medical help. Immediate surgery is required to remove oil.• Do not use finger or skin to check for leaks.• Lower load or relieve hydraulic pressure before loosening fittings.

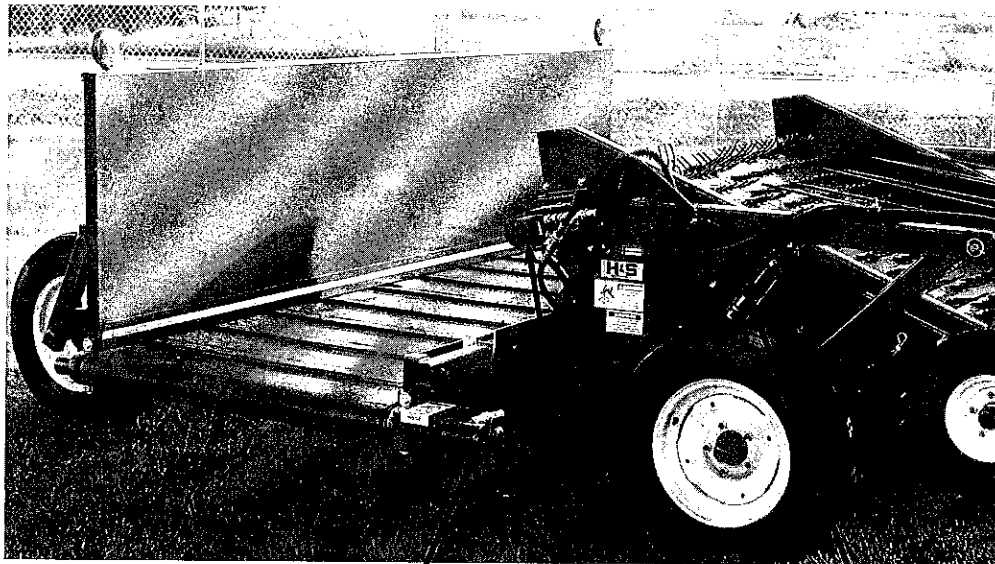

C

B

A

LUBRICATION

There are 18 grease fittings on your merger, 20 if equipped with an accelerator. If these are lubricated properly and often enough, it will prolong the life of the merger. Grease daily during normal use, and before and after storage. Use a good grade of high quality grease. Make sure grease comes out around the shaft on sleeve type bearings. On the sealed ball bearings, grease should be added slowly until a slight bead forms at the seals indicating the correct amount of lubricant. Wipe off excess grease to prevent accumulation of grit around the bearings. If equipped with accelerator, oil roller chain daily. Lubricate merger more often with extensive use.

- A. (4) - 1 on each bearing (both ends of cross conveyor)
- B. (1) - 1 on tail wheel pivot
- C. (4) - 2 on each side of pick-up pivot
- D. (2) - 1 on each bearing (both ends top pick-up drive roller)
- E. (2) - 1 on each bearing (both ends bottom pick-up idler roller)
- F. (2) - 1 on gauge wheel pivot
- G. (1) - 1 on right end wind deflector pivot
- H. (2) - 1 on each pole attachment pivot

OPTIONAL ACCELERATOR

- I. (2) - 1 on each bearing (both ends of accelerator shaft)

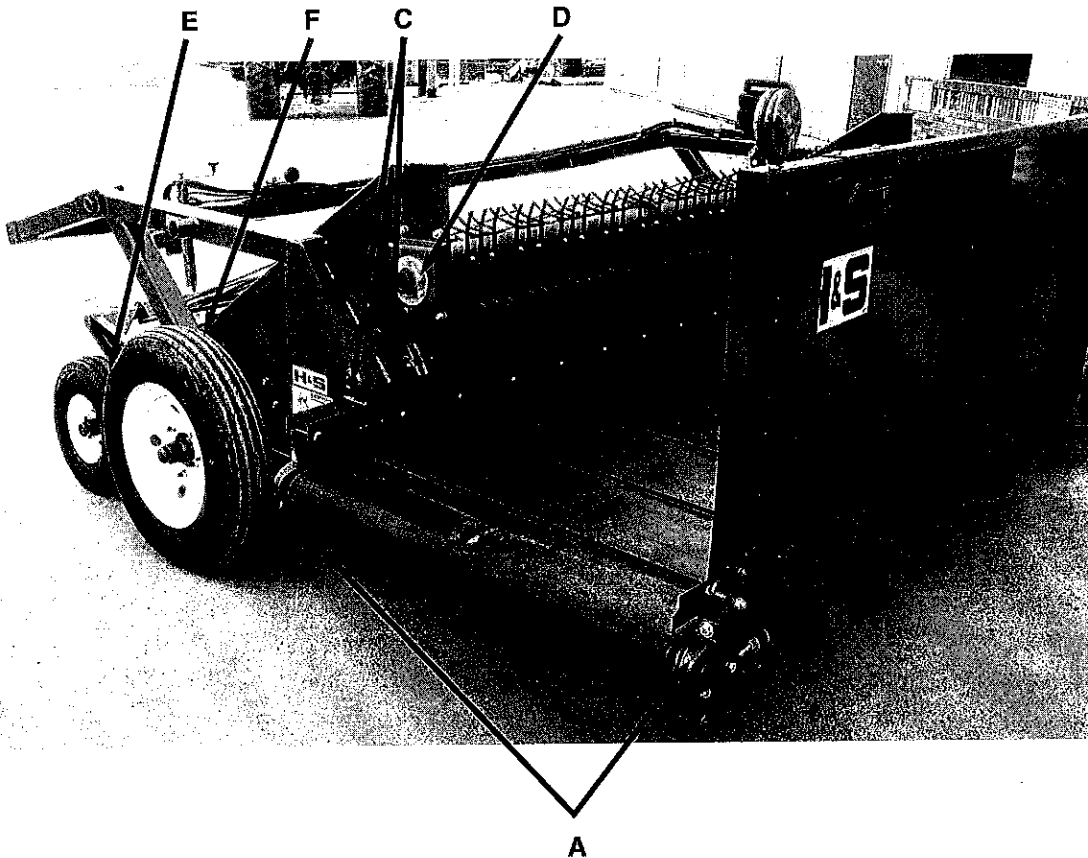

LUBRICATION (Continued)

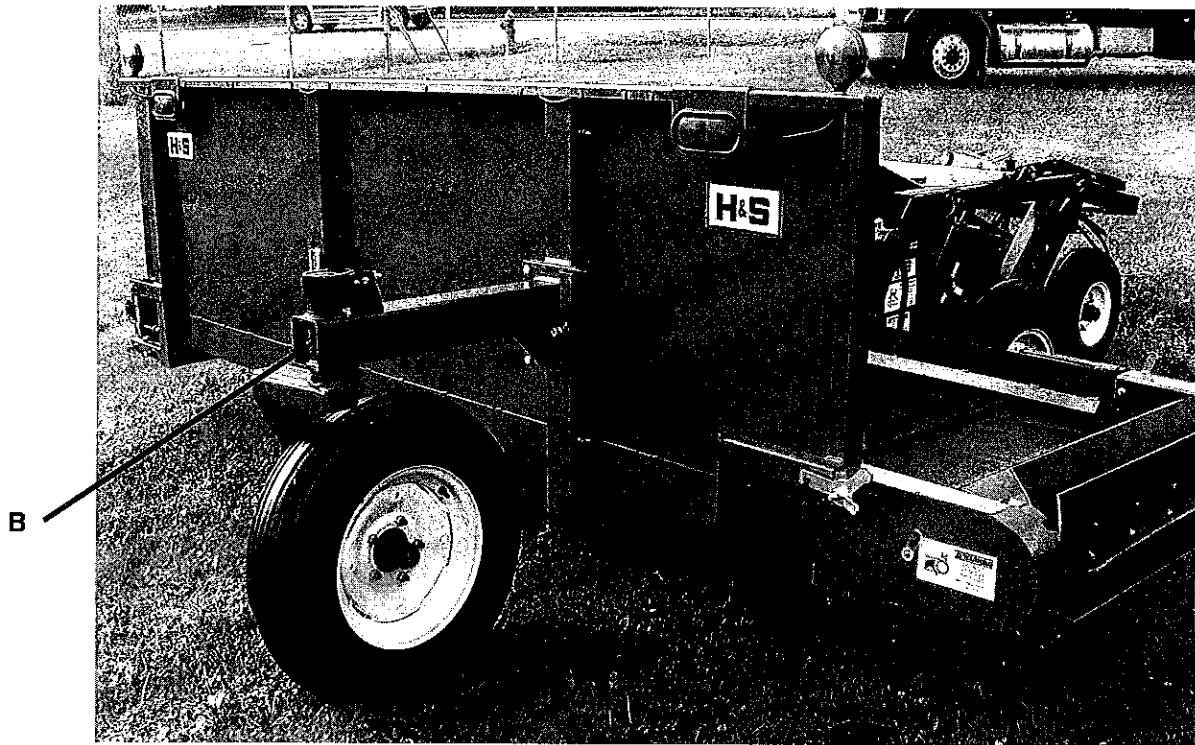

A I
(Under Shield)

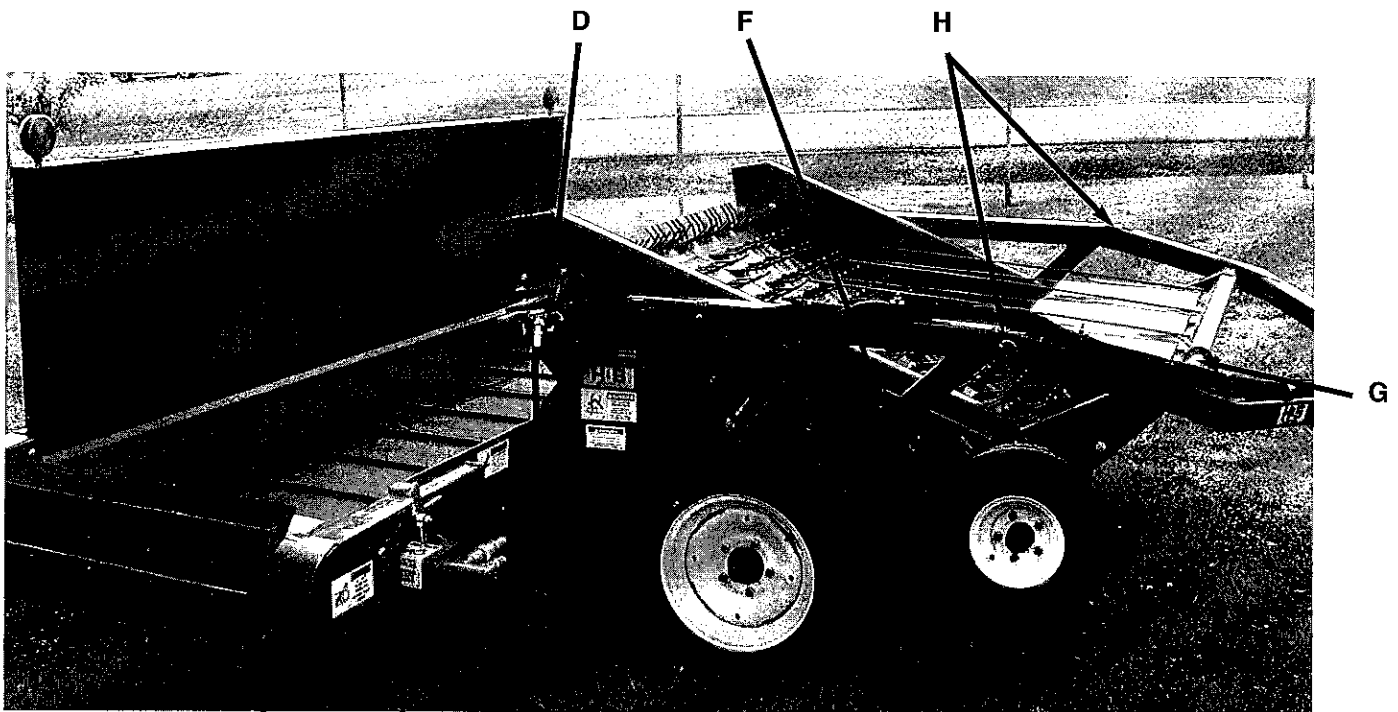

I A C E
(Under Shield)

OPTIONAL ACCELERATOR AND INVERTER

ACCELERATOR

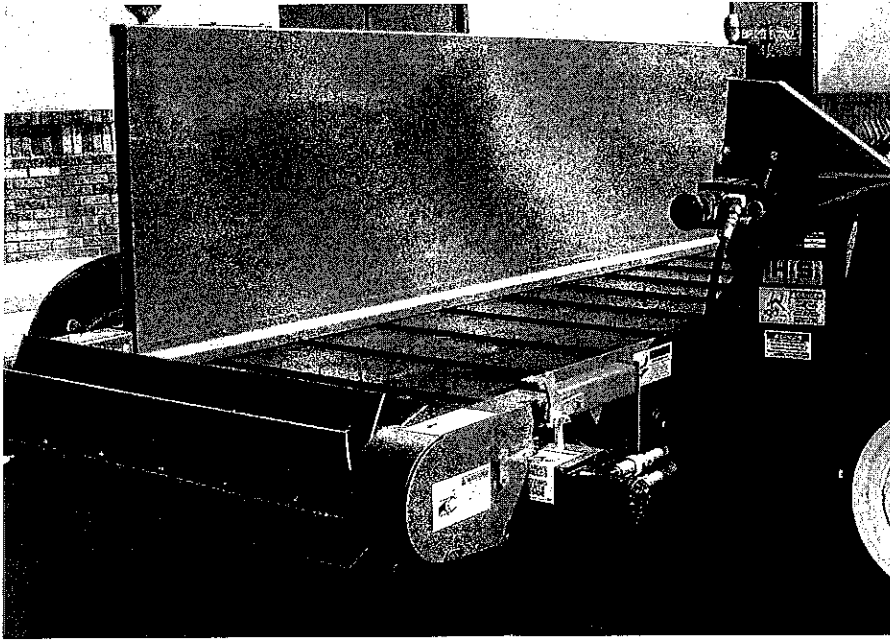

Remove accelerator for road transport

INVERTER

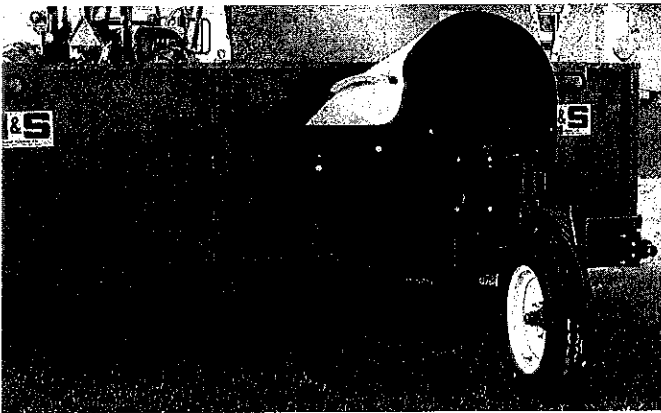

Transport Position

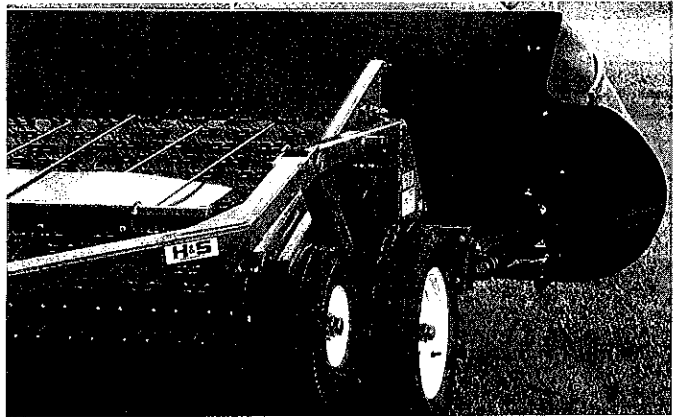

Working Position

Remove inverter for road transport

INSTRUCTIONS FOR ORDERING PARTS

All service parts should be ordered through your authorized H&S dealer. He will be able to give you faster service if you will provide him with the following.

1. Model & Serial Number - Both can be located on the right side main frame of your unit.
2. All reference to left or right apply to the machine as viewed from the rear.
3. Parts should not be ordered from illustration only. Please order by complete part number.
4. If your dealer has to order parts - give shipping instructions.

VIA truck - large pieces (please specify local truck lines)

VIA United Parcel Service (include full address)

H&S MFG. CO. INC.	
MARSHFIELD, WIS.	
MOD. NO.	<input type="text"/>
SER. NO.	<input type="text"/>
DESCR.	<input type="text"/>

PLEASE RECORD NUMBERS FOR YOUR UNIT FOR QUICK REFERENCE

ABOUT IMPROVEMENTS

H&S IS CONTINUALLY STRIVING TO IMPROVE ITS' PRODUCTS.

We must therefore, reserve the right to make improvements or changes whenever it becomes practical to do so, without incurring any obligation to make changes or additions to the equipment previously sold.

DECAL LOCATION

Your H&S 6' & 9' Merger was manufactured with operator safety in mind. Located on the windrow merger are various decals to aid in operation, and warn of danger or caution areas. Pay close attention to all the decals on your Mini Merger.



DO NOT REMOVE ANY OF THESE DECALS. IF DECALS ARE LOST, DAMAGED, OR IF MINI MERGER IS REPAINTED, REPLACE DECALS. REMEMBER: DECALS ARE FOR YOUR PROTECTION AND SAFETY.

Listed below are the decals on your Mini Merger. These decals may be ordered individually by part number or by ordering a complete set.

ITEM	PART NO.	DESCRIPTION
A.	B12	(2) H&S Decal
B.		(2) Red Reflective
C.	1494K	(2) Warning - Do Not Remove Shields
D.	B6	(4) H&S Decal
E.	11599	(2) Warning - Do Not Go Near Leaks
F.	3398A	(3) Danger - Stay Clear
G.	3398C	(2) Danger - Shut Engine Off Completely
H.	71188B	Jack Storage Position
I.	73101	(2) Danger - Stay Clear of Moving Parts (W/Accelerator Only)
J.		Serial #
K.	3894	(2) Warning - Do Not Operate (W/Accelerator Only)
L.	1494B	(2) Warning - Do Not Remove (W/Accelerator Only)
M.	72203A	Warning - Help Avoid Injury
N.		Operator Manual Holder
O.		(2) Amber Reflective
	11601MM1	Complete Set of Decals
Paint - H&S Red		
	ZX21	Gallon
	ZX22	Quart
	ZX23	Pint

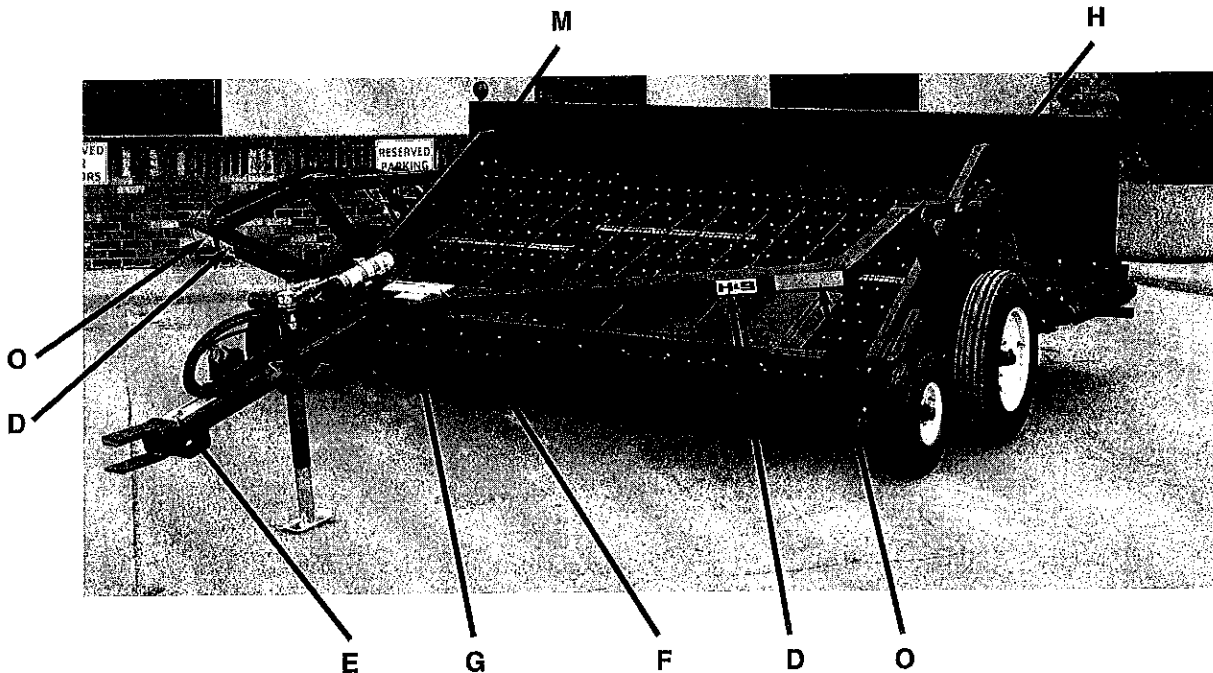

(Continued)

DECAL LOCATION (Continued)

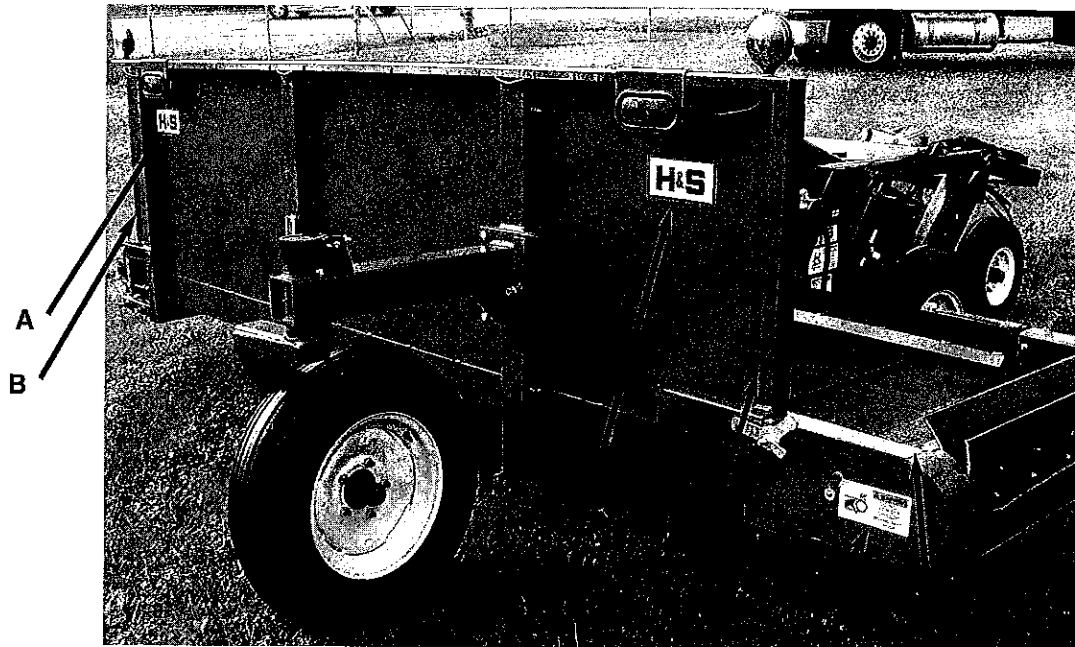

A B L I K
(Behind Shield)

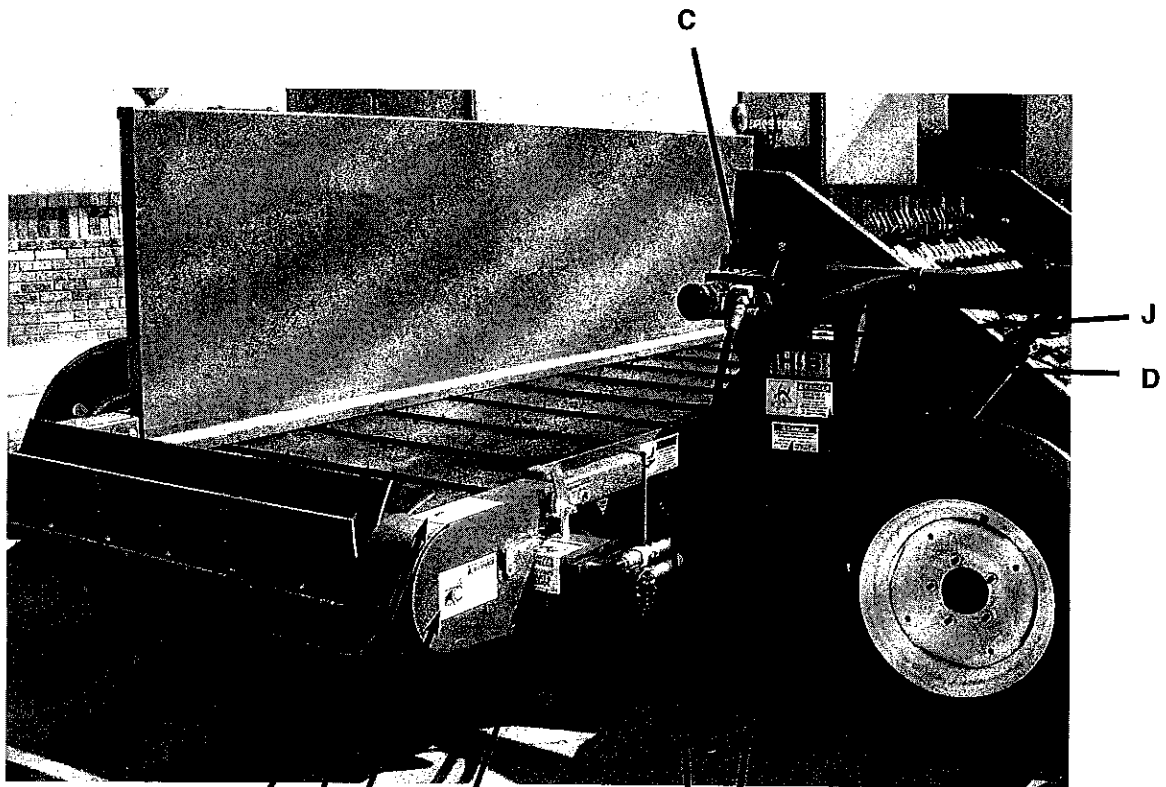

K I L C E G F
(Behind Shield)

FIGURE 1

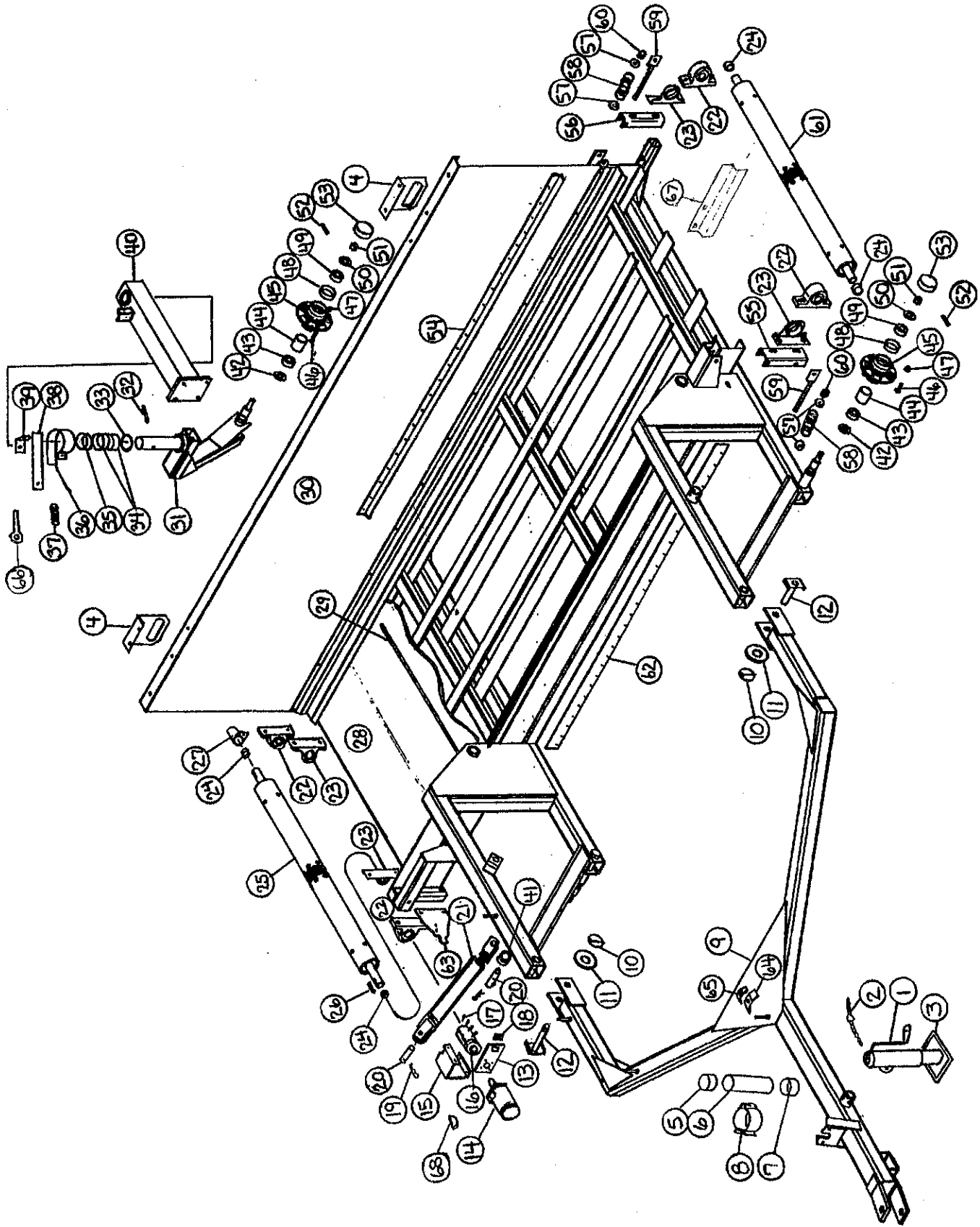
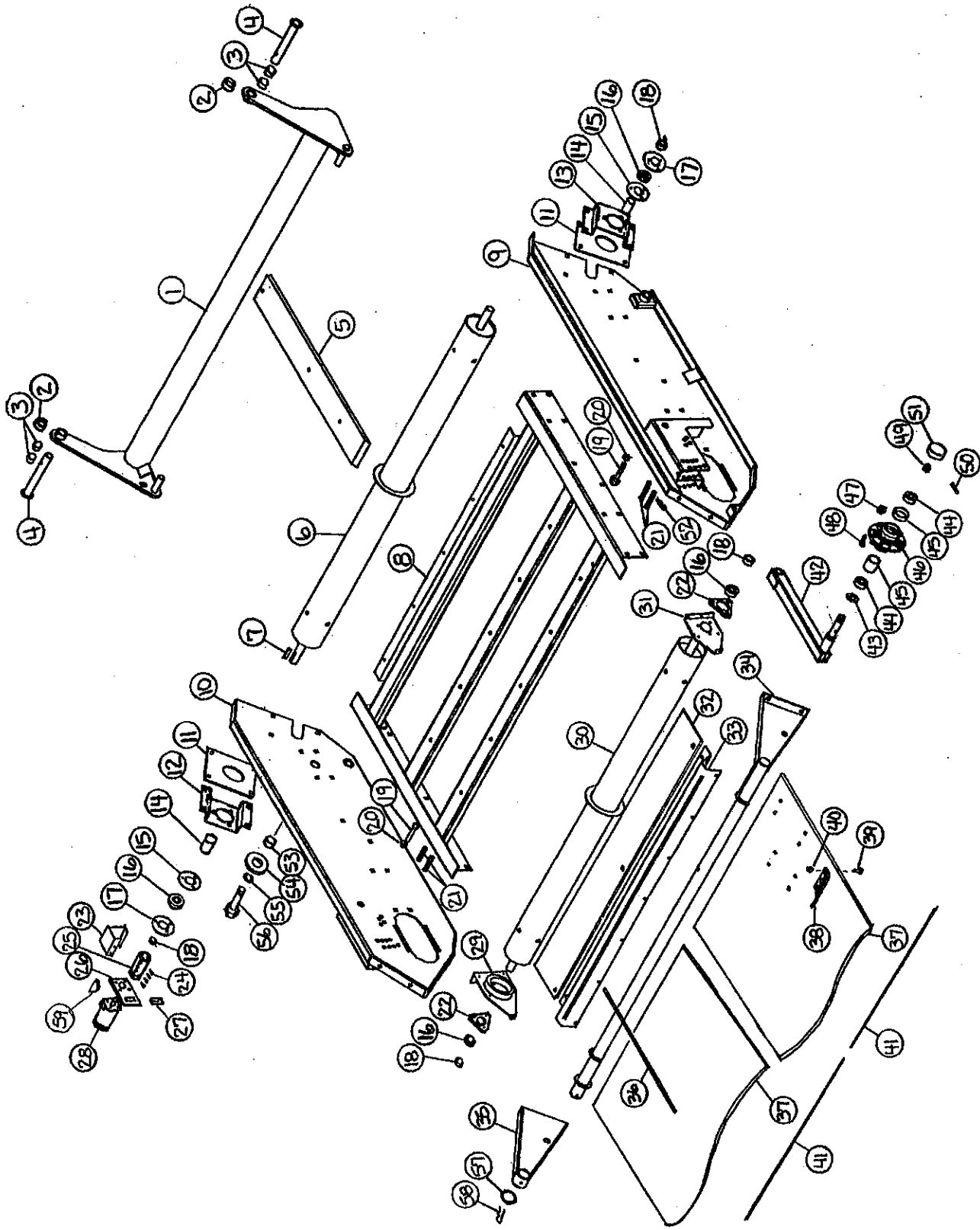

FIGURE 1
6' & 9' MERGER MAIN FRAME/POLE

ITEM	PART NO.		DESCRIPTION	ITEM	PART NO.		DESCRIPTION
	6' HEAD	9' HEAD			6' HEAD	9' HEAD	
1.	B17B	"	Jack Handle	36.	WM286	"	Brake Band
2.	BFR4	"	Jack Pin & Chain	37.	WM210	"	Spring-Red
3.	BFR223	"	Jack	38.	WM288	"	Brake Pad
4.	SWM28	"	Light Bracket	39.	WM211	"	Brake Angle
5.	S414	"	Cap	40.	SWM3	"	Caster Mount
6.	S415	"	Tube	41.	K132	"	Spacer
7.	S418	"	Cap W/Hole	42.	BFR57	"	Seal
8.	S416	"	Hanger Bracket	43.	BFR58	"	Inner Bearing
9.	SWM5	SWM65	Pole	44.	BFR59	"	Inner Race
10.	F56	"	Lynch Pin	45.	BFR60	"	Hub
11.	SWM36	"	Washer-Pivot	*	BFR67	"	Wheel 5 x 15 (3)
12.	SWM14	"	Pivot Pin	*	BFR128	"	Tire 6.70 x 15SL (3)
13.	DWM39	"	Torque Arm	46.	BFR143	"	Stud Bolt
14.	DF1	"	Hydraulic Motor	47.	BFR144	"	Nut
*	WM225	"	Seal Kit	48.	BFR61	"	Outer Race
15.	DWM42	"	Right Motor Shield	49.	BFR62	"	Outer Bearing
16.	DWM27	"	Coupler	50.	BFR63	"	Washer
17.	DWM137	"	Cap Screw-Coupler	51.	BFR64	"	Nut
18.	DWM45	"	Motor Spacer	52.	BFR65	"	Cotter Pin
19.	23N108	"	Cotter Pins 7/32" x 2"	53.	BFR66	"	Hub Cap
20.	BFR517	"	Cylinder Pin	54.	SWM29	WM236	Skirt
21.	BFR69A	"	Cylinder	55.	SWM34	"	Tightener Arm
22.	DWM132	"	Pillow Block Bearing	56.	SWM33	"	Back Tightener Arm
23.	DWM36	"	Anti-Wrap Guard	57.	K68	"	Washer 1/2"
24.	SWM30	"	Head Spacer	58.	DWM125	"	Spring-Blue
25.	SWM11	"	Driver Roller	59.	DWM25	"	Tightener
26.	G23	"	Key 5/16" x 1-3/8"	60.	R29	"	Nut 1/2"
27.	DWM31	"	Shaft Shield	61.	SWM10	"	Conveyor Roller
28.	SWM19	WM237	Conveyor Belt	62.	SWM16	WM235	Skirt Belt
29.	SWM37	"	Lacing Pin	63.	DWM51	"	Male Torque Arm
*	SWM38	"	Cross Conveyor Lacing	64.	HE42	"	Hose Holder (6)
30.	SWM7	SWM66	Main Frame	65.	23N67	"	Hose Holder (4)
31.	SWM2	"	Caster	66.	WM287	"	I-Bolt
32.	BFR313	"	Roll Pin 5/16" x 2-3/4"	67.	SWM59	"	Skirt Extention
33.	RG24	"	Bronze Washer 2"ID x 3"OD x 1/8"	68.	5B10	"	Key 1/4" x 1" Woodruff
34.	BFR527	"	Bronze Bushing 2"ID x 2-1/4"OD x 2"	* (Means Not Shown)			
35.	DWM59	"	Brake Bushing	" (Means Same As Previous)			

FIGURE 2



**FIGURE 2
6' & 9' MERGER PICK-UP HEAD**

ITEM	PART NO.		DESCRIPTION	ITEM	PART NO.		DESCRIPTION
	6' HEAD	9' HEAD			6' HEAD	9' HEAD	
1.	SWM12	WM230	Pickup Lifter	33.	SWM9	DWM2	Wind Guard Holder
2.	SWM30	"	Spacer	34.	SWM32	DWM228	Wind Guard
3.	RG132	"	Bushing 1-1/4"ID x 2" Long	35.	DWM226	"	Right Wind Guard
4.	SWM13	"	Pin	36.	WM60	"	Wind Guard Rods
5.	SWM15	"	Plastic Slides (5) 6' - (8) 9'	37.	SWM56	"	Pickup Belts Only (2) 6' - (3) 9'
6.	SWM6	WM232	Back Roller	*	SWM57	"	Pickup Belt Complete w/Teeth
7.	G23	"	Key 5/16" x 1-3/8"	*	SWM61	"	Repair Dutchman Kit
8.	SWM8	WM234	Pickup Belt Frame	38.	SWM1	"	Pickup Teeth (260)
9.	DWM3	"	Left Panel	39.	SWM26	"	1/4" x 3/4" Elevator Bolts
10.	DWM4	"	Right Panel	40.	SWM27	"	1/4" Keps Lock Nuts
11.	WM180	"	Side Panel Slot Plate	41.	SWM41	"	Lacing Pin
12.	WM187	"	Bearing Bracket RH	*	SWM39	"	Alligator Lace
13.	WM186	"	Bearing Bracket LH	42.	DWM229	"	Gauge Arms
14.	WM185	"	PVC Spacer	43.	CAT135A	"	Seal
15.	F145	"	Heavy Duty Flange	44.	CAT10	"	Bearing (2)
16.	WM29	"	Bearing	45.	CAT9	"	Race (2)
17.	F143	"	Flange W/45 Deg. Zerk	46.	CAT177	"	Hub-Complete
18.	WM27	"	Lock Collar	47.	BFR144	"	Lug Nut
19.	DWM7	"	Pivot Pin	48.	CAT128	"	Stud
20.	F56	"	Lynch Pin	49.	CAT12	"	Spindle Nut
21.	DWM127	"	Clevis Pin	50.	BFR65	"	Cotter Pin
22.	SWM40	"	3-Bolt Bearing Housing	51.	CAT13	"	Hub Cap
*	SWM35	"	3-Bolt Bearing Complete	*	SWM17	"	Wheel (2)
23.	DWM43	"	Head Shield	*	SWM18	"	Tire 5.70-8 (2)
24.	DWM137	"	Cap Screw-Coupler	52.	ES7	"	Hair Pin
25.	DWM27	"	Coupler	53.	WM183	"	Pivot Bushing
26.	DWM39	"	Hydraulic Motor Mount	54.	WM218	"	Washer
27.	DWM45	"	Motor Spacer	55.	DWM171	"	1" Lock Washer
28.	WM177	"	Hydraulic Motor	56.	DWM177	"	Bolt 1" x 2-1/2" GR.5 Full Thd.
*	WM225	"	Seal Kit	57.	DWM227	"	Wind Guard Washer
29.	WM179	"	Right Front Roller Bracket	58.	SWM49	"	Cotter Pin 7/32" x 2-1/2"
30.	SWM4	WM233	Front Roller	59.	5B10	"	Key 1/4" x 1" Woodruff
31.	WM192	"	Left Front Roller Bracket	* (Means Not Shown)			
32.	SWM31	DWM58	Poly Wind Guard	" (Means Same As Previous)			

FIGURE 3

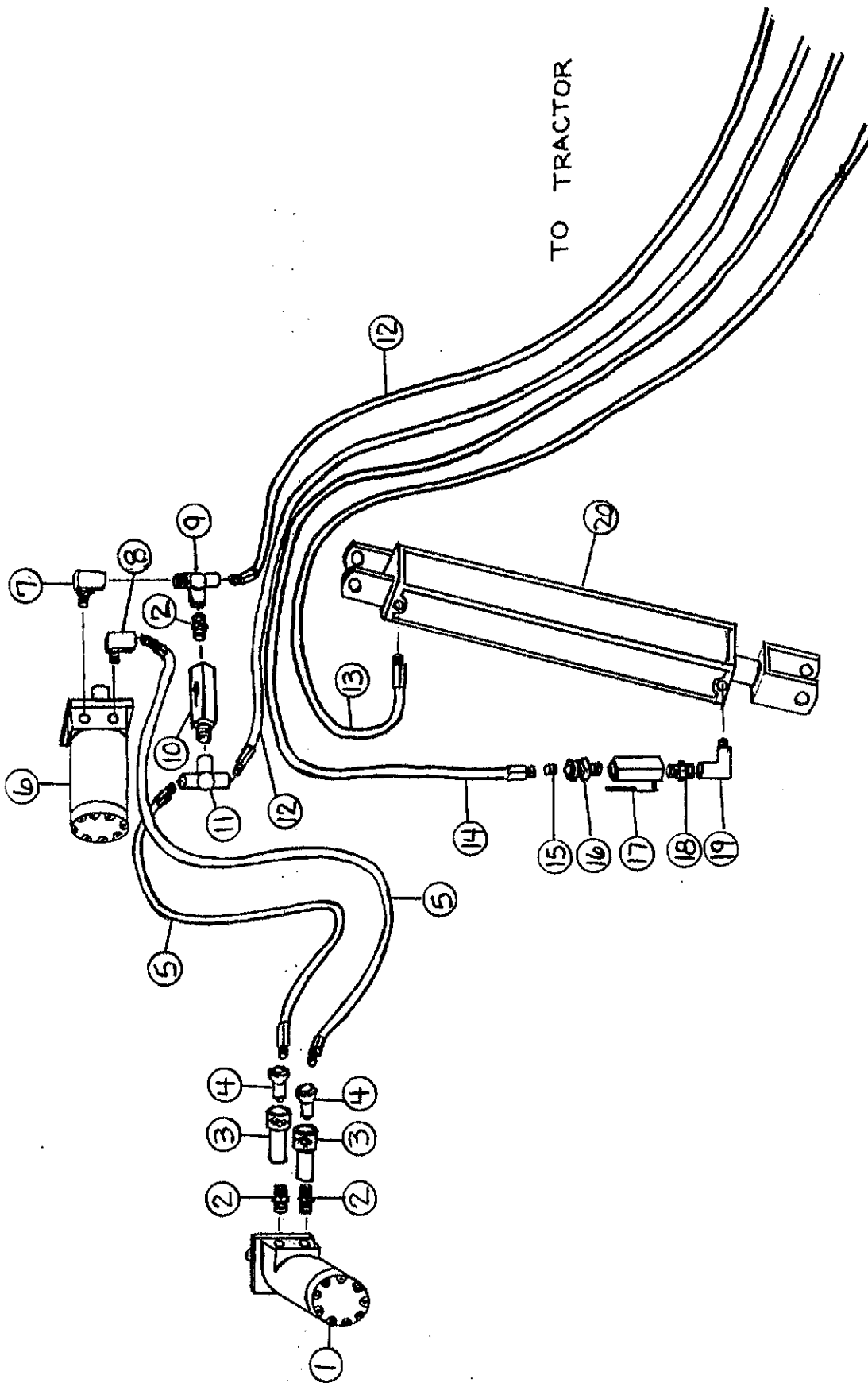

**FIGURE 3
6' & 9' MERGER HYDRAULICS**

ITEM	PART NO.		DESCRIPTION
	6' HEAD	9'HEAD	
1.	DF1	"	Hyd. Motor-Cross Conveyor
*	WM225	"	Seal Kit
2.	WM141	"	1/2" Nipple Nut
3.	DWM206	"	Female Coupler
4.	DWM205	"	Male Coupler
5.	SWM23	"	Hose 1/2" x 42"
6.	WM177	"	Hyd. Motor-Pickup
*	WM225	"	Seal Kit
7.	LW174	"	1/2" Male Adapter Union
8.	HE58	"	1/2" Street Elbow
9.	LW96	"	1/2" Street Tee
10.	DF18	"	1/2" Check Valve
11.	DF8	"	1/2" Tee
12.	SWM22	----	Hose 1/2" x 216"
	----	SWM67	Hose 1/2" x 240"
13.	SWM24	----	Hose 1/4" x 180"
	---	SWM68	Hose 1/4" x 204"
14.	SWM25	----	Hose 1/4" x 190"
	----	SWM69	Hose 1/4" x 214"
15.	DWM250	"	Orifice .042
16.	BFR122	"	3/8" Male Adapter Union
*	T244	"	Adapter Union & Orifice
17.	16SV338	"	3/8" Ball Valve
18.	BFR188	"	3/8" Nipple Nut
19.	23N234	"	3/8" Street Elbow
20.	BFR69A	"	2" x 8" Cylinder

* (Means Not Shown)
 " (Means Same As Previous)
 ---- (Means Not Used On This Model)

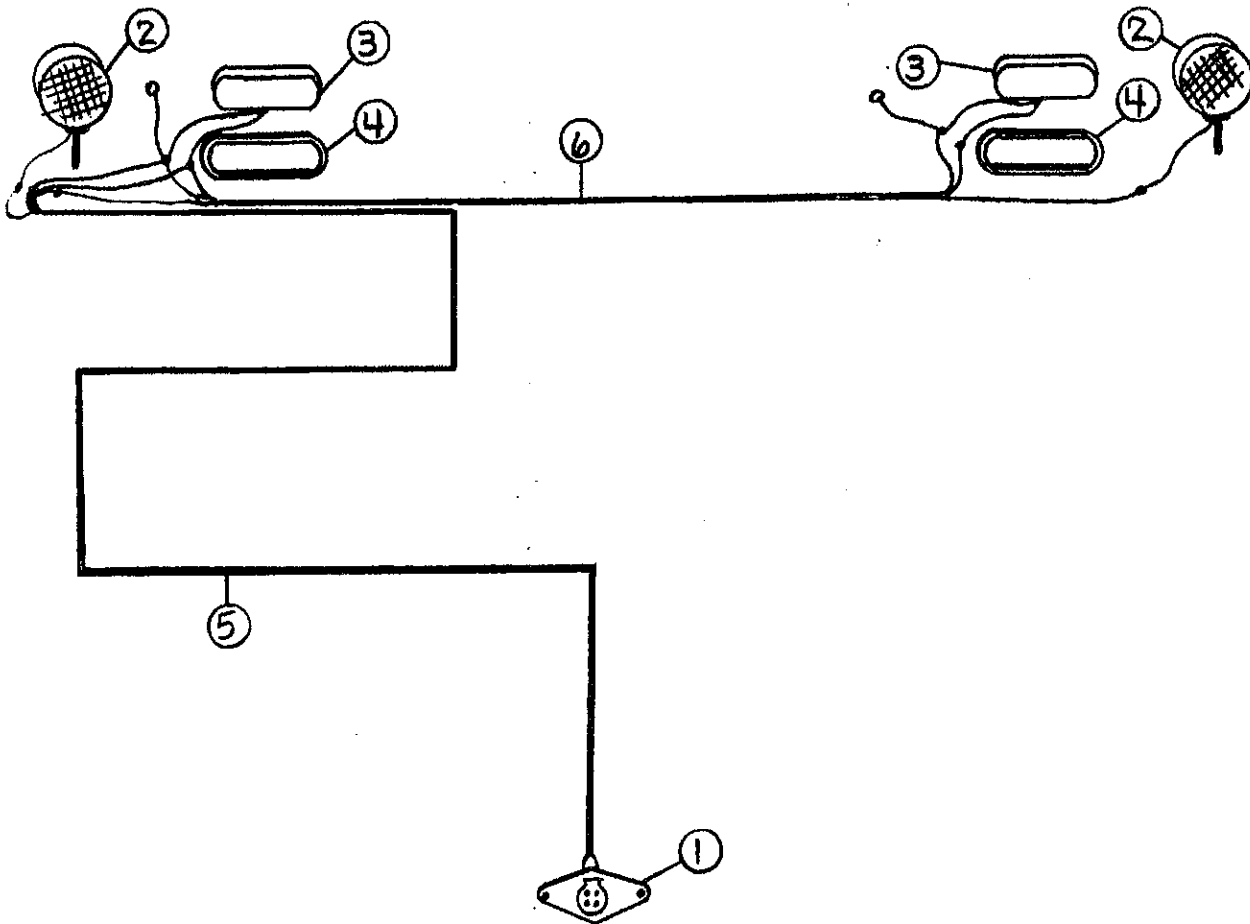

FIGURE 4
6' & 9' MERGER ELECTRICAL WIRING / LIGHTS

ITEM	PART NO.		DESCRIPTION
	6' HEAD	9'HEAD	
1.	SWM46	"	Plug In
2.	DWM129	"	Yellow Hazard Lights
3.	S310	"	Red Tail Lights
4.	S308	"	Rubber Light Mount
5.	SWM47	SWM70	Main Wire
6.	SWM48	SWM71	2nd Wire
7.	S317	"	Optional Tractor Cord

* (Means Not Shown)

" (Means Same As Previous)

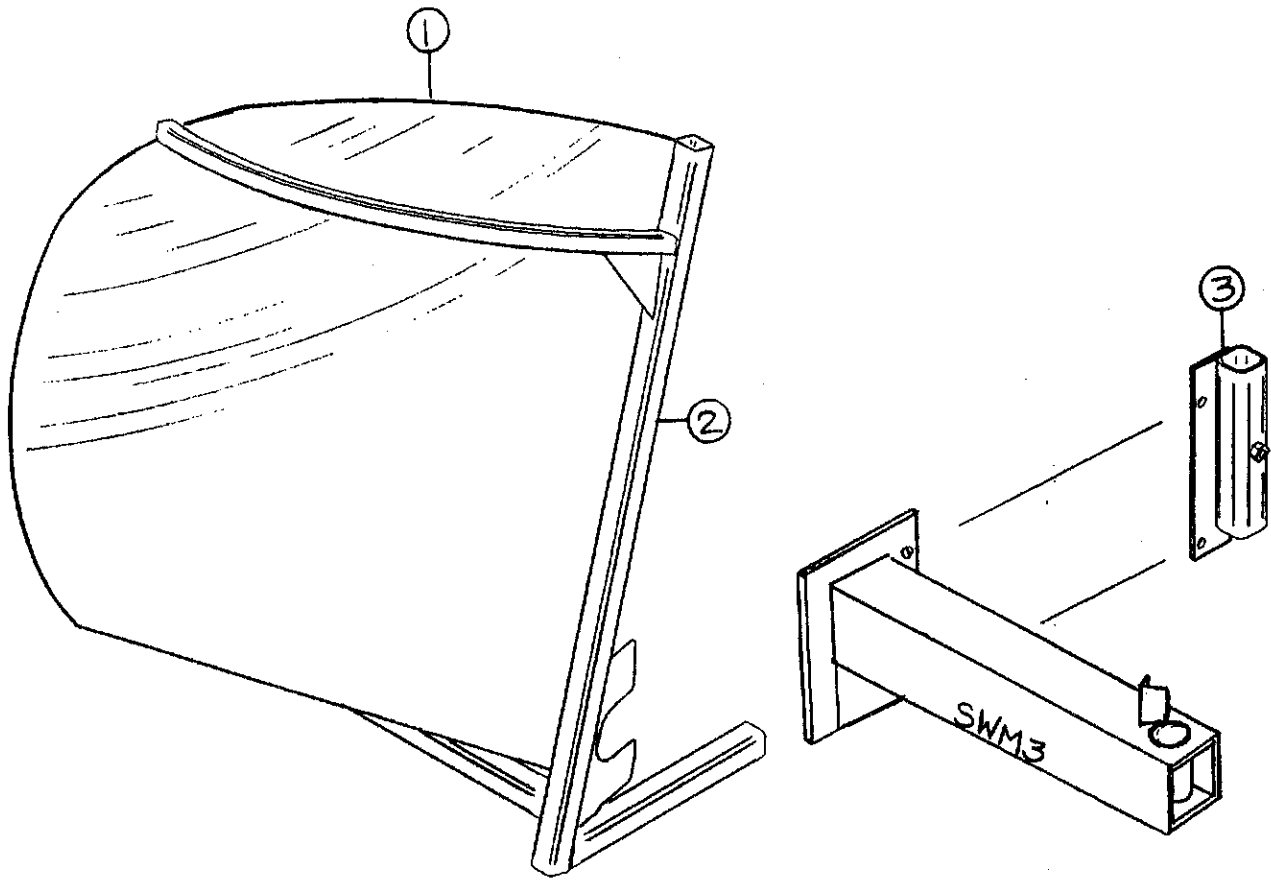

FIGURE 5
6' & 9' MERGER OPTIONAL WINDROW INVERTER

ITEM	PART NO.	DESCRIPTION
1.	SWM50	Windrow Inverter Poly
2.	SWM51	Windrow Inverter Frame
3.	SWM52	Storage Mount

(NOTE: Storage Mount Bolts onto SWM3 Caster Mount - See Fig. 1)

FIGURE 6

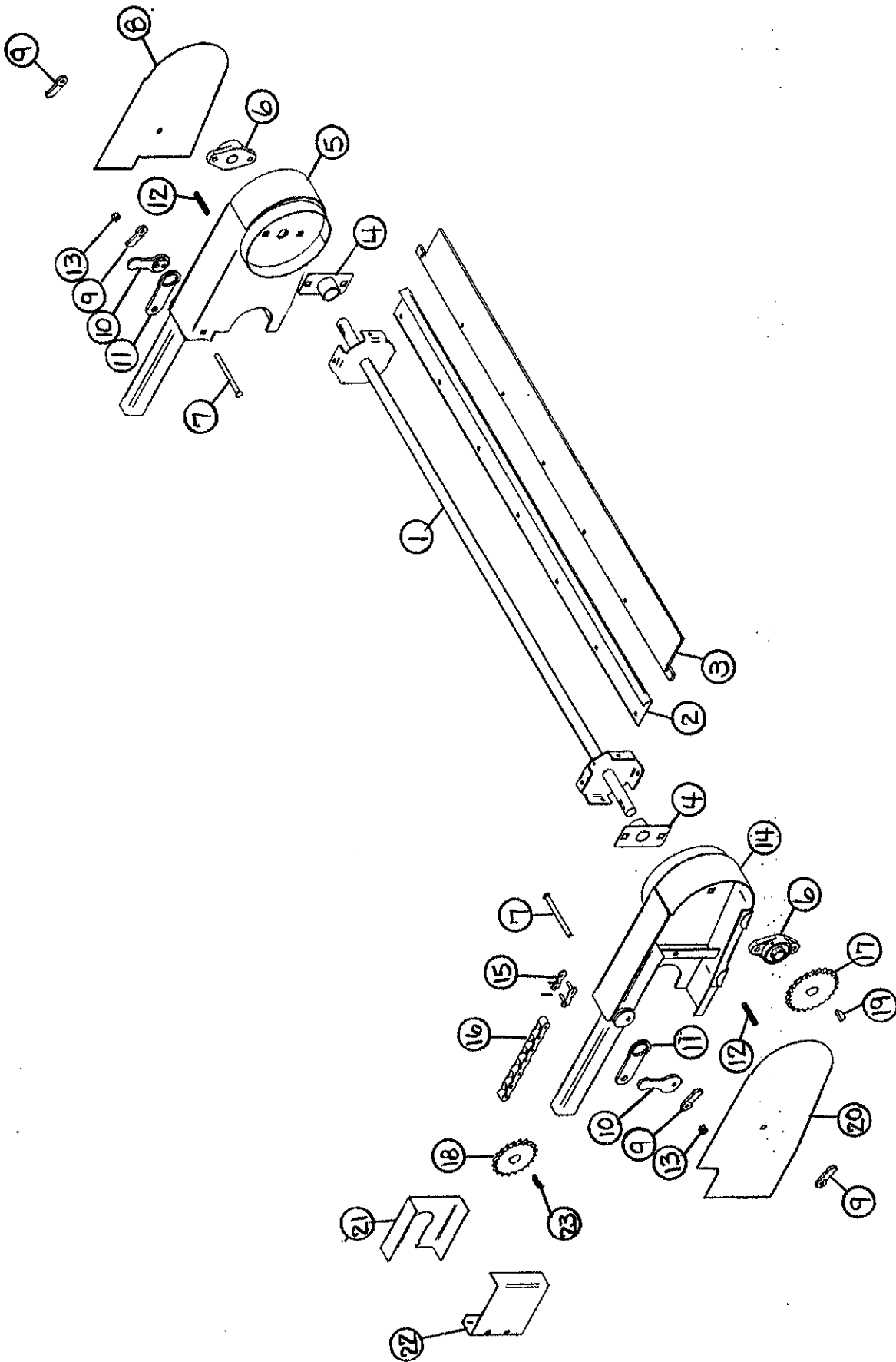

FIGURE 6
6' & 9' MERGER OPTIONAL ACCELERATOR

ITEM	PART NO.	DESCRIPTION
1.	SWM42	Accelerator Shaft
2.	SWM43	Accelerator Plate
3.	SWM44	Rubber
4.	DWM211	Wrap Guard
5.	DWM208	Mounting Bracket 1
6.	DWM221	1" Bearing
7.	DWM222	3/8" x 5-1/2" Carriage Bolt GR.5
8.	DWM214	Shield 1
9.	DWM219	Handle Nut
10.	DWM210	Latch Handle
11.	DWM217	Latch
12.	DWM218	Ready Rod
13.	A14	3/8" Nylock Nut
14.	DWM209	Mounting Bracket 2
15.	X61	#50 Connector Link
16.	SWM53	#50 Roller Chain 57 Pitch
17.	X106	Sprocket 24T 1" Bore
18.	SWM45	Sprocket 17T 1-1/4" Bore
19.	5B10	Woodruff Key 1/4" x 1"
20.	DWM213	Shield
21.	DWM216	Sprocket Shield Back
22.	DWM215	Sprocket Shield
23.	S135	1/4" x 1-1/4" Sq. Key
*	SWM58	Complete Accelerator Kit

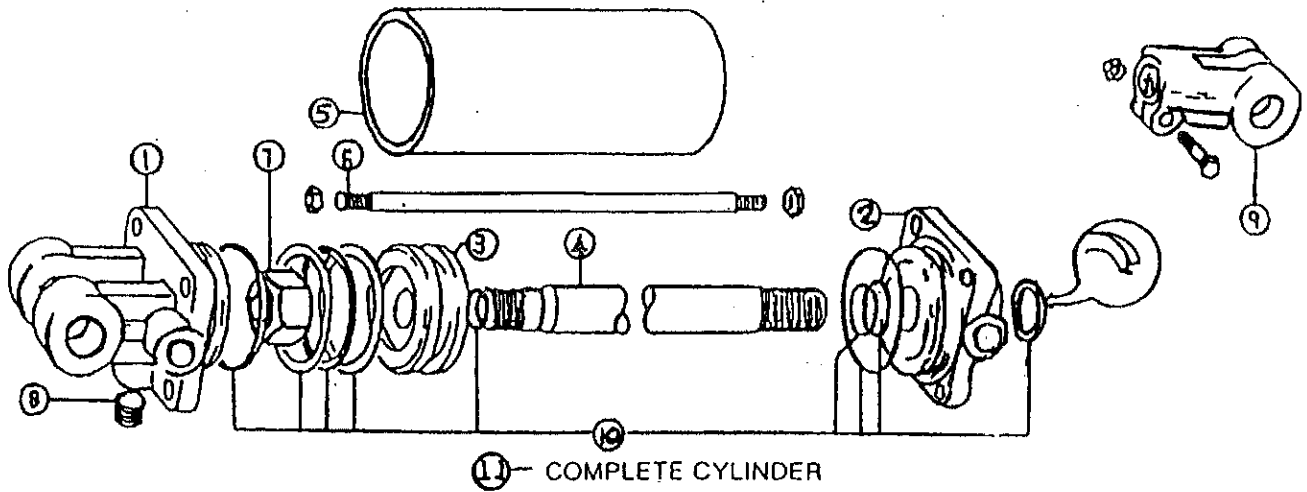

FIGURE 7
6' & 9' MERGER
HYDRAULIC CYLINDER 8"

ITEM	PART NO.	DESCRIPTION
1.	23N142A	Clevis Cap
2.	23N143A	Rod Cap
3.	23N144	Piston
4.	T134A	Rod
5.	BFR68	Cylinder Tube
6.	T186	Tie Rod
7.	23N148	Piston Nut
8.	23N149	Plug
9.	23N150A	Rod Clevis
10.	23N151	Seal Kit
11.	BFR69A	Complete Cylinder

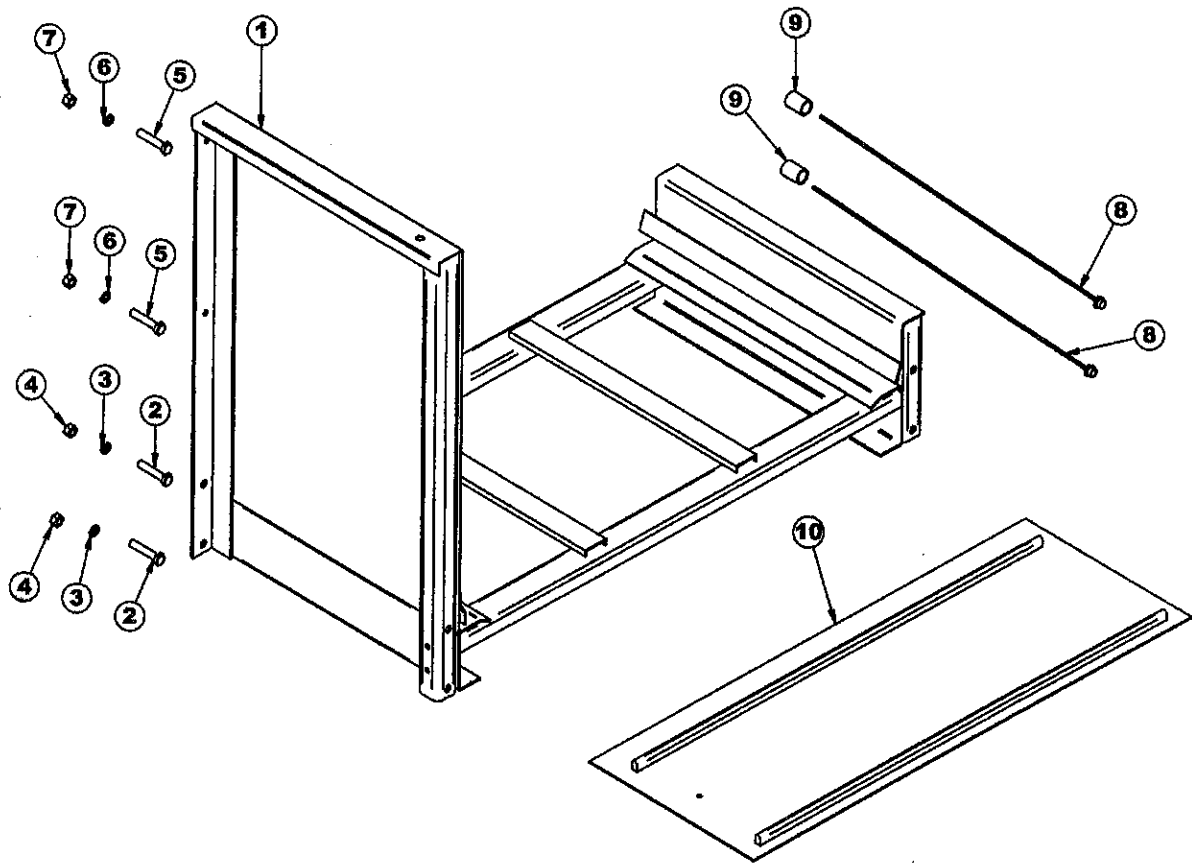

FIGURE 8
6' & 9' Merger 2' Extension

ITEM	PART NO.	DESCRIPTION
1.	SWM62	Extension
2.	WM328	1/2" x 2-3/4" Bolt Gr. 5
3.	R35	1/2" Lock Washer
4.	R29	1/2" Nut
5.	12N51	3/8" x 2-3/4" Bolt Gr. 5
6.	B68	3/8" Lock Washer
7.	K60	3/8" Nut
8.	16SV141	1/2" x 24" Hose (1/2"MP & 1/2"MPX)
9.	PB105	1/2" Pipe Coupler
10.	WM214	Belt Extension
*	WM220	Lacing Pin
*		30" - 16 Ga Wire

* (Means Not Shown)

H&S 6' & 9' MERGERS

Your new H&S Mini Merger has been manufactured of the finest quality materials and components. The performance you get from your machine is largely dependent upon how well you read and understand this manual and apply this knowledge. There is a right and a wrong way to do everything. Please do not assume that you know how to operate and maintain your Mini Merger before reading this manual carefully. Keep this manual available for ready reference.

6' & 9' MERGER SPECIFICATIONS

Base Unit Height	4'6"
Base Unit Width	11'1"
Base Unit Length	19'3"
Base Unit Weight	2340 Lbs.
Tire Size (Frame)	6.70-15SL
Tire Size (Pickup)	5.7-8
Individual Pickup Width	6' in 36" Sections
Cross Conveyor Width	42"
Tractor Size	Recommended 50 H.P.
Hydraulic Capacity Needed	16 GPM/2000 PSI
Merging Capabilities	
Base Unit	7'-12'
Base Unit with Accelerator	7'-14'

SPECIFICATIONS SUBJECT TO CHANGE WITHOUT NOTICE

H&S MANUFACTURING CO. INC.

2608 S. Hume Ave.
P.O. Box 768 - Telephone (715) 387-3414
FAX (715) 384-5463
MARSHFIELD, WI 54449



H&S WAREHOUSE Rt. #5 and 76
P.O. Box 1260 - Telephone (716) 736-7595
FAX (716) 736-7596
RIPLEY, NY 14775

H&S MFG. CO.

products approved

for the

FEMA

SEAL OF QUALITY

